

FB12NCX

8Ω

Crossovers

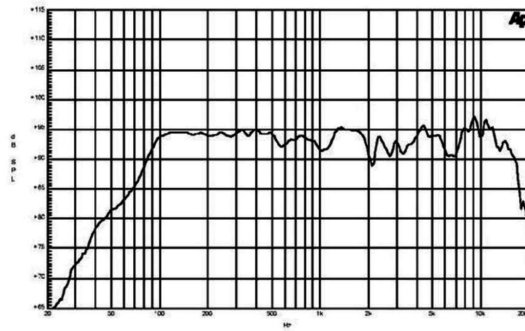
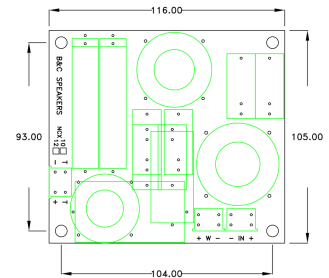
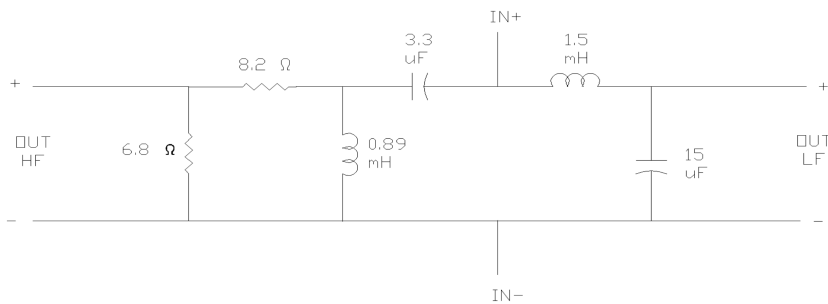
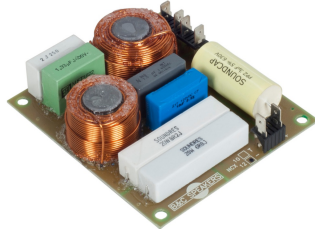

DESCRIPTION

Dedicated crossover network for 12NCX coaxial speaker

SPECIFICATIONS

Nominal Impedance	8 Ω
Crossover Frequency	1.8 kHz
Filter Type	Two Way
Low-pass Slope	12.0 dB/oct
High-pass Slope	12.0 dB/oct
Overall Dimensions	116x105 mm (4.57x4.13 in)

MOUNTING AND SHIPPING INFO

Net Weight	0.5 kg (1.1 lb)
Shipping Units	1
Shipping Weight	0.53 kg (1.16 lb)
Shipping Box	120x125x35 mm (4.72x4.92x1.38 in)
Other Details	6 mm diameter holes on the PCB at 104 mm x 93 mm